

Features

- 17" Industrial Compact Size Panel PC
- Flat front panel touch screen
- Fanless design
- Intel Celeron N2930(1.83GHz) CPU built-in
- Onboard 4GB DDR3L 1333 MHz/8GB(option)
- Wide range DC 9~36V power input
- IP66 compliant front panel
- Optional projected capacitive touch screen support 7H anti-scratch surface
- High brightness 1,000nits LCD for ARCHMI-817(P)H
- Optical bonding for option
- Auto dimming for option for ARCHMI-817(P)H



Specifications

System	
CPU	Onboard Intel Celeron N2930(1.83GHz) Processor
System Chipset	SoC
Memory	Onboard 4GB DDR 3L 1333 MHz/8GB(option)
IO Port	
USB	2 x USB 3.0 type A
Serial/Parallel	1 x RS-232 DB-9, COM2 1 x RS-232/422/485 DB-9, COM1, default RS-232
Audio	1 x Audio Line Out
LAN	2 x GbE LAN RJ-45 with Intel 82574L controller
Power	1 x 3-pin DC power input terminal 1 x 2-pin connector for power on/off button
Option	2 x RS-232 DB-9 + 1 x Mini-PCIe slot via TB-528C2ME1 2 x CAN bus via TB-528CAN2 2 x USB 2.0 type A Via TB-528U2 2 x USB 2.0 type A + 1 x RS-232 DB-9 + 1 x Power button via TB-528C1U2P1 UPS Battery 21W/10.8V/1.95Ah(3S1P)

Storage Space	
HDD	1 x SATA 2.5" HDD bay for SATA HDD (easy accessible)
movable device	1 x SD card slot, up to 32GB

Expansion	
Expansion Slot	1 x Internal Mini-PCIe slot full size

Display	ARCHMI-817(P)	ARCHMI-817(P)H
Display Type	17" TFT-LCD	17" TFT-LCD
Max. Resolution	1280 x 1024	1280 x 1024
Max. Color	16.2M	16.7M
Luminance (cd/m ²)	350	1000
Viewing Angle	170(H) / 160(V)	170(H) / 160(V)
Contrast Ratio	1000 : 1	1000 : 1
Backlight Lifetime	30,000 Hrs	50,000 Hrs

Touch Screen	
Type	Resistive Touch Window Projected Capacitive Touch (For P Model)
Interface	USB
Light Transmission(%)	Resistive Touch Window: over 80% Projected Capacitive Touch: over 90%

Power	
Power Input	DC 9~36V
Power Consumption	ARCHMI-817: MAX: 22.1W / ARCHMI-817P: MAX: 20.5W ARCHMI-817H: MAX: TBD / ARCHMI-817PH: MAX: TBD

Dimensions

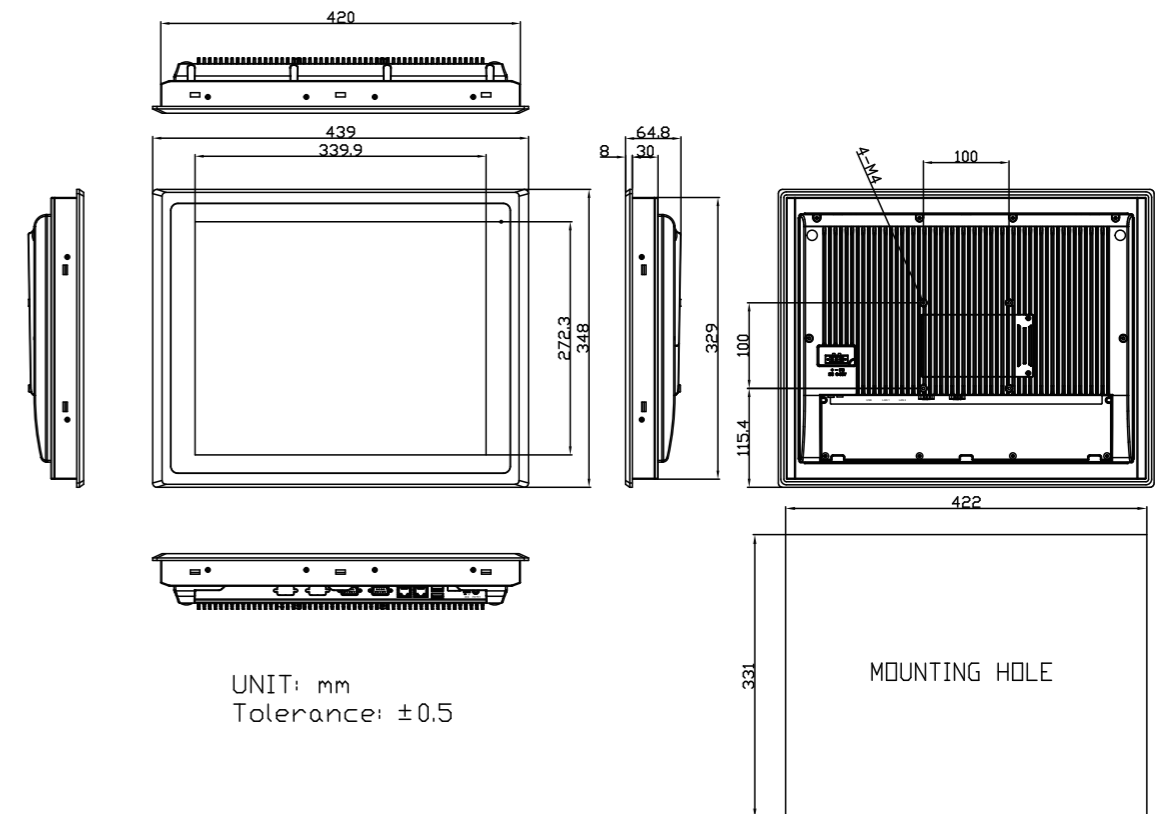

Mechanical	
Color	RAL 9007
Construction	Aluminum Die-casting Front Bezel and Chassis
Mounting	Panel Mounting, VESA 100 x 100
IP Rating	IP66 compliant front bezel
Dimensions	439 x 348 x 64.8 mm
Net Weight	ARCHMI-817(P): 6 Kg ARCHMI-817(P)H: TBD

Environmental	
Operating Temperature	0~50°C
Storage Temperature	-20~60°C
Storage Humidity	10 to 90%@ 40°C, non-condensing
Certificate	CE / FCC CLASS A / UL

Operating System Support	
Windows Embedded Compact 7, Windows Embedded Standard 7, Windows 7 Pro(FES), Windows 7 Ultimate(FES), Windows Embedded 8 Standard, Windows Embedded 8.1 Industry Pro, Windows 10 IoT Enterprise 2015LTSP	

Ordering Information	
ARCHMI-817-01	17" SXGA Fanless HMI barebone with Intel Celeron N2930 1.83GHz CPU, 2GB DDR3L RAM, Resistive touch screen, DC 9~36V input with adapter, Aluminum chassis
ARCHMI-817P-01	17" SXGA Fanless HMI barebone with Intel Celeron N2930 1.83GHz CPU, 2GB DDR3L RAM, Projected capacitive touch screen, DC 9~36V input with adapter, Aluminum chassis
ARCHMI-817H-01	17" SXGA Fanless HMI barebone with Intel Celeron N2930 1.83GHz CPU, 4GB DDR3L RAM, Resistive touch screen, DC 9~36V input with adapter, Aluminum chassis, High brightness 1,000nits LCD
ARCHMI-817PH-01	17" SXGA Fanless HMI barebone with Intel Celeron N2930 1.83GHz CPU, 4GB DDR3L RAM, Projected capacitive touch screen, DC 9~36V input with adapter, Aluminum chassis, High brightness 1,000nits LCD